

ORIHOMEDICAL

G m b H · I M P L A N T S

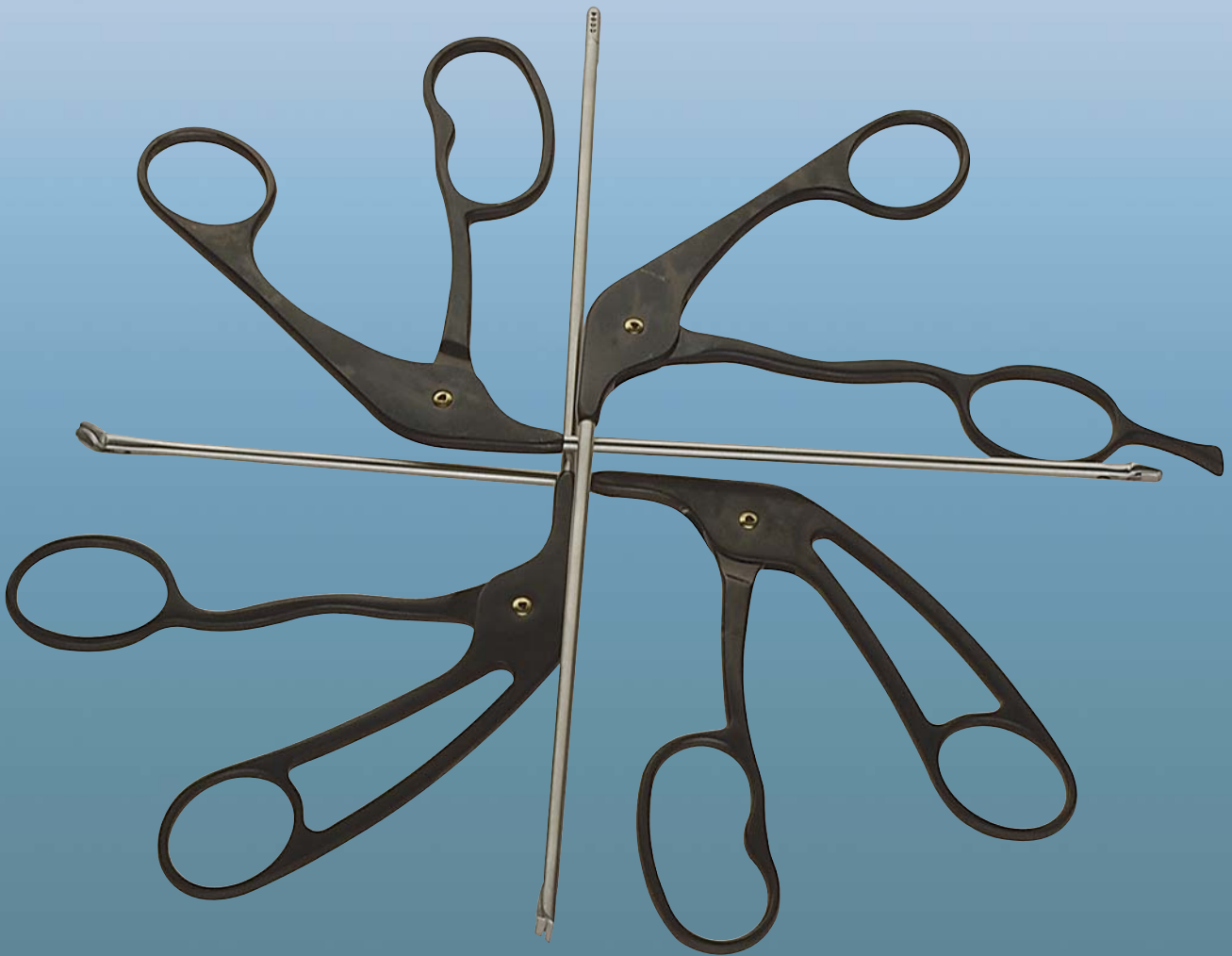

Arthroskopie Instrumente
Arthroscopy Instruments



When ordering please indicate #
Example 54-774.40

Handle













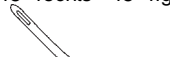

When ordering please indicate #
Example 54-774.30

Arthroskopie / Arthroscopy

Alle Instrumente mit Überlastungsschutz
All Instruments with Overload Protection















	ø mm	Hakenschere Hook Scissors	Hakenstanze mit Schaufel Hook Punch with Scoop	Hakenstanze abgesetzt Hook Punch set down	Hakenstanze Schnitt eckig Hook Punch Cut angular
			 L = 5,0 mm · B = 1,6 mm	 L = 5,0 mm · B = 1,6 mm	 L = 5,0 mm · B = 1,6 mm
gerade · straight	2,7	54-825.xx	54-843.xx	54-879.xx	
	3,5	54-826.xx	54-844.xx	54-880.xx	54-897.xx
30° rechts · 30° right	2,7	54-827.xx	54-845.xx	54-881.xx	
	3,5	54-828.xx	54-846.xx	54-882.xx	54-898.xx
30° links · 30° left	2,7	54-829.xx	54-847.xx	54-883.xx	
	3,5	54-830.xx	54-848.xx	54-884.xx	54-890.xx
45° rechts · 45° right	2,7	54-831.xx	54-849.xx	54-885.xx	
	3,5	54-832.xx	54-850.xx	54-886.xx	54-961.xx
45° links · 45° left	2,7	54-833.xx	54-851.xx	54-887.xx	
	3,5	54-834.xx	54-852.xx	54-888.xx	54-862.xx
7° auf · 7° up	2,7	54-835.xx	54-853.xx	54-889.xx	
	3,5	54-836.xx	54-854.xx	54-890.xx	54-963.xx
7° auf · 7° down	2,7	54-837.xx	54-855.xx	54-891.xx	
	3,5	54-838.xx	54-856.xx	54-892.xx	54-964.xx
15° auf · 15 up	2,7	54-839.xx	54-857.xx	54-893.xx	
	3,5	54-840.xx	54-858.xx	54-894.xx	54-965.xx
15° ab · 15° down	2,7	54-841.xx	54-859.xx	54-895.xx	
	3,5	54-842.xx	54-860.xx	54-896.xx	54-966.xx

Arthroskopie / Arthroscopy

Alle Instrumente mit Überlastungsschutz
All Instruments with Overload Protection













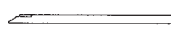

	ø mm	Hakenstanze 15° aufwärts gefräst Hook Hook Punch 15° up milled	Breitmaulstanze groß Wide Jaw Punch large	Breitmaulstanze mittel Wide Jaw Punch medium	Breitmaulstanze klein Wide Jaw Punch small
		 L = 5,0 mm · B = 1,6 mm	 L = 5,0 mm · B = 4,5 mm	 L = 5,0 mm · B = 3,5 mm	 L = 6,0 mm · B = 2,5 mm
gerade · straight 	3,5	54-701.xx	54-710.xx	54-719.xx	54-728.xx
30° rechts · 30° right 	3,5	54-702.xx	54-711.xx	54-720.xx	54-729.xx
30° links · 30° left 	3,5	54-703.xx	54-712.xx	54-721.xx	54-730.xx
45° rechts · 45° right 	3,5	54-704.xx	54-713.xx	54-722.xx	54-731.xx
45° links · 45° left 	3,5	54-705.xx	54-714.xx	54-723.xx	54-732.xx
7° auf · 7° up 	3,5	54-706.xx	54-715.xx	54-724.xx	54-733.xx
7° auf · 7° down 	3,5	54-707.xx	54-716.xx	54-725.xx	54-734.xx
15° auf · 15 up 	2,7	54-708.xx	54-717.xx	54-726.xx	54-735.xx
15° ab · 15° down 	3,5	54-709.xx	54-718.xx	54-727.xx	54-736.xx

Arthroskopie / Arthroscopy

Alle Instrumente mit Überlastungsschutz
All Instruments with Overload Protection





	ø mm	Breitmaulstanze groß 15°aufwärts gefräst Wide Jaw Punch large 15° up milled  L = 5,0 mm · B = 4,5 mm	Breitmaulstanze mittel 15°aufwärts gefräst Wide Jaw Punch medium 15° up milled  L = 5,0 mm · B = 3,5 mm	Breitmaulstanze klein 15° aufwärts gefräst Wide Jaw Punch small 15° up milled  L = 6,0 mm · B = 2,5 mm	Breitmaulstanze klein 45° aufwärts gefräst Wide Jaw Punch small 45° up milled  L = 6,0 mm · B = 2,0 mm
gerade · straight 	3,5	54-764.xx	54-773.xx	54-782.xx	54-998.xx
30° rechts · 30° right 	3,5	54-765.xx	54-774.xx	54-783.xx	
30° links · 30° left 	3,5	54-766.xx	54-775.xx	54-784.xx	
45° rechts · 45° right 	3,5	54-767.xx	54-776.xx	54-785.xx	
45° links · 45° left 	3,5	54-768.xx	54-777.xx	54-786.xx	
7° auf · 7° up 	3,5	54-769.xx	54-778.xx	54-787.xx	
7° auf · 7° down 	3,5	54-770.xx	54-779.xx	54-788.xx	
15°auf · 15 up 	3,5	54-771.xx	54-780.xx	54-789.xx	
15° ab · 15° down 	3,5	54-772.xx	54-781.xx	54-790.xx	

Arthroskopie / Arthroscopy

Alle Instrumente mit Überlastungsschutz
All Instruments with Overload Protection















	∅ mm	45° Hakenschere 45° Hook Scissors	45° Stanze mit Schaufel 45° Punch with Scoop	45° Stanze stumpf 45° Punch blunt	90° Stanze mit Schaufel 90° Punch with Scoop	90° Stanze stumpf 90° Punch blunt
			 L = 4,5 mm · B = 1,6 mm	 L = 4,5 mm · B = 1,6 mm	 L = 4,5 mm · B = 1,6 mm	 L = 4,5 mm · B = 1,6 mm
rechts abgewinkelt right angled	3,5	54-791.xx	54-794.xx	54-798.xx	54-802.xx	54-806.xx
links abgewinkelt left angled	3,5	54-792.xx	54-796.xx	54-800.xx	54-804.xx	54-808.xx

	∅ mm	90° Breitmaulstanze mittel 90° Wide Jaw Punch medium	90° Breitmaulstanze klein 90° Wide Jaw Punch small
		 L = 7,0 mm · B = 3,0 mm	 L = 7,0 mm · B = 1,8 mm
rechts abgewinkelt right angled	3,5	54-809.xx	54-811.xx
links abgewinkelt left angled	3,5	54-810.xx	54-812.xx

Arthroskopie / Arthroscopy

Alle Instrumente mit Überlastungsschutz
All Instruments with Overload Protection



	ø mm	Scherenstanze Scissors Punch  L = 5,0 mm · B = 0,8 mm	Scherenstanze 15° aufwärts geätzt Scissors Punch 15° up milled  L = 5,0 mm · B = 0,8 mm	Stanze Retrograd Schnitt links Punch Retrograde Cut left  L = 4,0 mm · B = 2,5 mm	Stanze Retrograd Schnitt rechts Punch Retrograde Cut right  L = 4,0 mm · B = 2,5 mm
gerade · straight 	3,5	54-967.xx	54-976.xx	54-985.xx	54-986.xx
30° rechts · 30° right 	3,5	54-968.xx	54-977.xx		
30° links · 30° left 	3,5	54-969.xx	54-978.xx		
45° rechts · 45° right 	3,5	54-970.xx	54-979.xx		
45° links · 45° left 	3,5	54-971.xx	54-980.xx		
7° auf · 7° up 	3,5	54-972.xx	54-981.xx		
7° auf · 7° down 	3,5	54-973.xx	54-982.xx		
15° auf · 15 up 	3,5	54-974.xx	54-983.xx		
15° ab · 15° down 	3,5	54-975.xx	54-984.xx		

Arthroskopie / Arthroscopy

Alle Instrumente mit Überlastungsschutz
All Instruments with Overload Protection



	∅ mm	Fasszange Grasping Forceps	Fasszange 1x2 Zähne Grasping Forceps 1x2Teeth	Fasszange 1x2 Zähne Grasping Forceps 1x2 Teeth	Fass- und Biopsiezange Grasping and Biopsy Forceps	Biopsie-Löffel- Zange BiopsySpoon Forceps
ohne Sperre without Ratched	2,7					
	3,5					
		54-987.xx				
		54-988.xx	54-989.xx	54-990.xx	54-991.xx	54-997.xx

Arthroskopie-Instrumente, Dreiecksgriff
Arthroscopy-Instruments, Triangular Handle



55-005.18
 Hakensonde graduiert
 Hook probe graduated
 3 mm



55-005.30
 Meniskotom nach Smilie
 Smilie knife
 5 mm



55-005.36
 Messer spitz
 Traditional knife, sharp



55-005.37
 Messer sichelförmig
 Sickle knife



55-005.25
 Hakenmesser
 Hook knife



55-005.38
 Löffel 3 mm ø
 Spoon 3 mm ø



55-005.39
 Messer retrograd
 Knife, retrograde



55-005.35
 Ring-Kürette, 3 mm ø
 Ring Curette, 3 mm ø

Banana-Messer
 Banana knife



55-005.40 glatt / smooth



55-005.41 gezahnt / serrated



55-005.42
 Rosettenmesser
 Rosette knife

Arthroskopie-Instrumente, gerändelter Griff, 4 mm Ø
Arthroscopy-Instruments with knuled handle, 4 mm Ø



Hakenmesser 90°
Hook-Knife 90°
55-001.00

5 mm



Meniskotome
Meniscotome
55-001.01



Messer 45°
Knife 45°
55-001.02



Bananenmesser
Banana-Knife
55-001.03



Skalpelmesser
Scalpel-Knife
55-001.04

4 mm



Hakensonde 4 mm
Hook-Probe 4 mm
55-001.05

3 mm



Smillie Meniskotome
3 mm breit
Smillie Meniscotome
3 mm width
55-001.06



Rosettenmesser
gerade
Rosetten-Knife
straight
55-001.07



Bananenmesser
gezahnt
Banana-Knife
serrated
55-001.08

Ø 3 mm



Löffel 3 mm Ø
30° gebogen
Spoon 3 mm diameter
30° curved
55-001.09

Ø 3 mm



Ring-Kürette 3 mm Ø
30° gebogen
Ring-Curette 3 mm
diameter, 30° curved
55-001.10

Arthroskopie-Instrumente, gerändelter Griff, 4 mm Ø
Arthroscopy-Instruments with knuled handle, 4 mm Ø



Hakensonde spitz
Hook probe pointed
55-003.01



Messer 45°
Knife 45°
55-003.02



Bajonett
Bajonet Kinfe
55-003.03



Sichelmesser
Sickle Knife
55-003.04



Hackknemesser 90°
Hook Knife 90°
55-003.05



Skalpellmesser
Scalpel-Knife
55-003.06



Messer gezahnt, gerade
Knife toothed, straight
55-003.07



Messer gezahnt, gebogen 30°, links
Knife toothed, curved 30°, left
55-003.08



Messer gezahnt, gebogen 30°, rechts
Knife toothed, curved 30°, right
55-003.09



Bananenmesser gezahnt,
Banana-Knife toothed,
55-003.10



Bananenmesser glatt,
Banana-Knife smooth,
55-003.11



Löffel 3 mm Ø
30° gebogen
Spoon 3 mm Ø
30° curved
55-003.12

Ø 3 mm



Ring-Kürette
3 mm Ø
Ring-Curette
3 mm Ø

55-003.13

Ø 7 mm



Ring-Kürette
7 mm Ø
Ring-Curette
7 mm Ø

55-003.14

3 mm



Meniskotome
Smillie 3 mm
gerade Schneide
Meniscotome
Smillie 3 mm
Straight edge
55-003.15

5 mm



Meniskotome
Smillie 5 mm
gerade Schneide
Meniscotome
Smillie 5 mm
Straight edge
55-003.16

7 mm



Meniskotome
Smillie 7 mm
gerade Schneide
Meniscotome
Smillie 7 mm
Straight edge
55-003.17

2,5 mm



Sonde graduiert
2,5 mm
Probe graduated
2.5 mm

55-003.18

3,5 mm



Sonde graduiert
3,5 mm
Probe graduated
3.5 mm

55-003.19

Griff alleine 125 mm
Handle only 125 mm
55-003.00

Arthroskopie-Instrumente, gerändelter Griff, 4 mm Ø
Arthroscopy-Instruments with knuled handle, 4 mm Ø

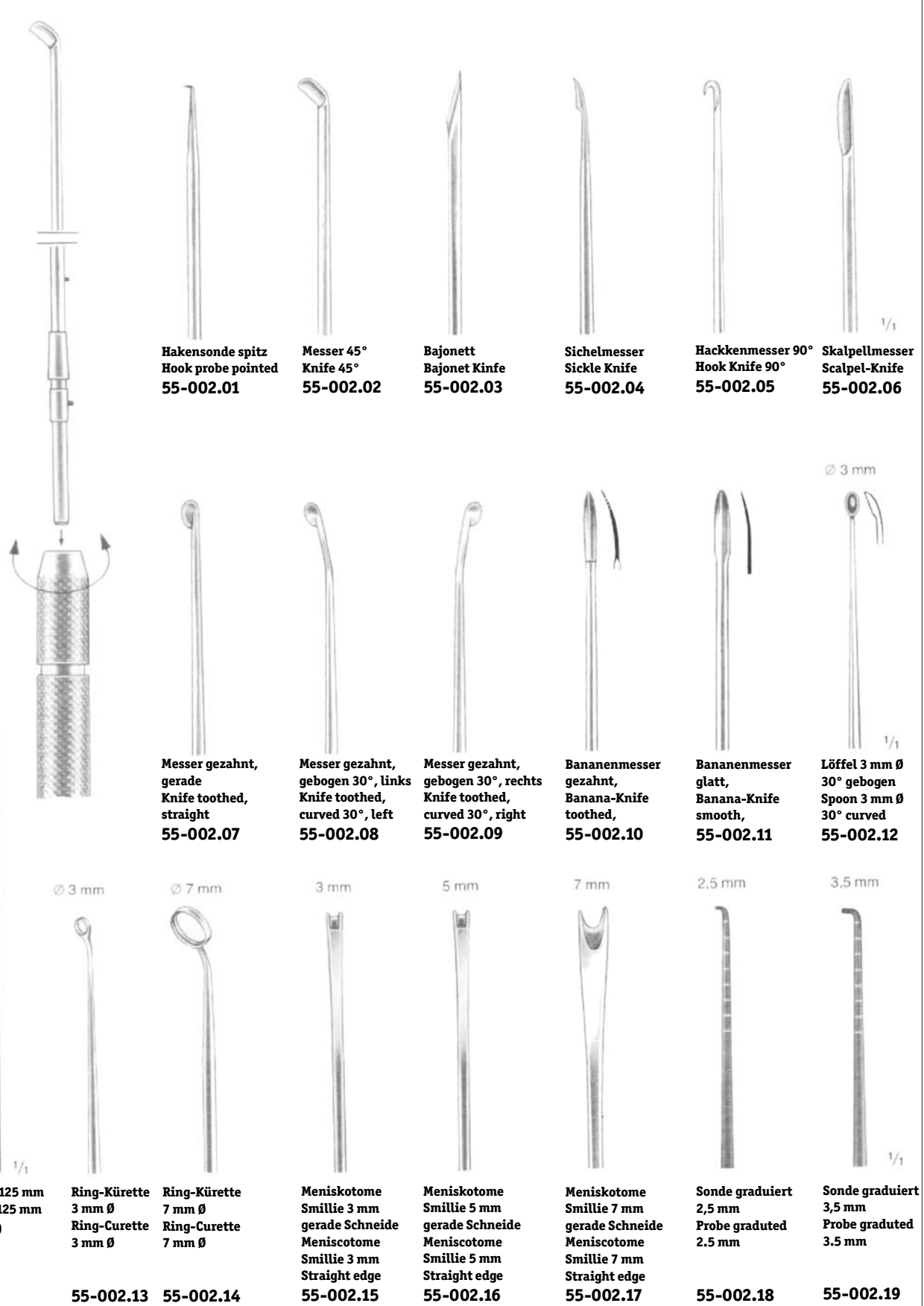

Hakensonde spitz
Hook probe pointed
55-002.01

Messer 45°
Knife 45°
55-002.02

Bajonett
Bajonet Kinfe
55-002.03

Sichelmesser
Sickle Knife
55-002.04

Hackenmesser 90°
Hook Knife 90°
55-002.05

Skalpellmesser
Scalpel-Knife
55-002.06

Messer gezahnt, gerade
Knife toothed, straight
55-002.07

Messer gezahnt, gebogen 30°, links
Knife toothed, curved 30°, left
55-002.08

Messer gezahnt, gebogen 30°, rechts
Knife toothed, curved 30°, right
55-002.09

Bananenmesser gezahnt, Banana-Knife toothed,
55-002.10

Bananenmesser glatt, Banana-Knife smooth,
55-002.11

Löffel 3 mm Ø
Spoon 3 mm Ø
30° gebogen
30° curved
55-002.12

Ø 3 mm

Ø 7 mm

3 mm

5 mm

7 mm

2.5 mm

3.5 mm

Griff alleine 125 mm
Handle only 125 mm
55-002.00

Ring-Kürette
3 mm Ø
Ring-Curette
3 mm Ø

Ring-Kürette
7 mm Ø
Ring-Curette
7 mm Ø

Meniskotome
Smillie 3 mm
gerade Schneide
Meniscotome
Smillie 3 mm
Straight edge
55-002.15

Meniskotome
Smillie 5 mm
gerade Schneide
Meniscotome
Smillie 5 mm
Straight edge
55-002.16

Meniskotome
Smillie 7 mm
gerade Schneide
Meniscotome
Smillie 7 mm
Straight edge
55-002.17

Sonde graduiert
2,5 mm
Probe graduated
2.5 mm
55-002.18

Sonde graduiert
3,5 mm
Probe graduated
3.5 mm
55-002.19

55-002.13

55-002.14

**Trocar Sleeves and Trocars
Dyonics Shaft 30° two rotatable Stopcocks**

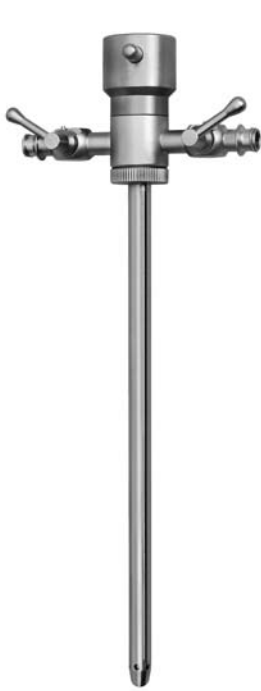

Shaft 30° complete
Ø4 mm length 138 mm
55-305.01



Trocar sharp
55-305.10



Trocar blunt
55-305.20

Stryker Shaft 30° two rotatable Stopcocks



Shaft 30° complete
Ø4 mm length 115.5 mm
55-310.01



Trocar sharp
55-310.10



Trocar blunt
55-310.20

Trocar Sleeves and Trocars

Universal Shaft two rotatable Stopcocks



Shaft Universal

2.7Ø length 175 mm
2.7Ø length 187.5 mm
55-300.01
55-301.01

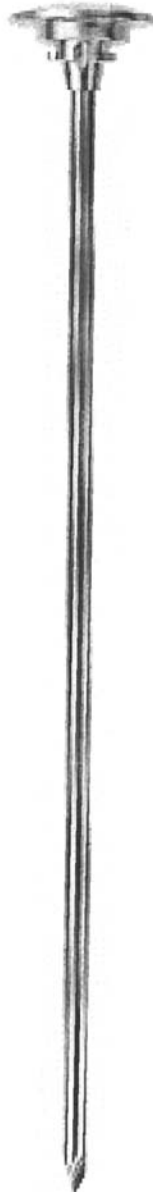

Trocar

2.7Ø length 175 mm
2.7Ø length 187.5 mm
55-300.10
55-301.10



Obturator conic

2.7Ø length 175 mm
2.7Ø length 187.5 mm
55-300.20
55-301.20



Obturator

2.7Ø length 175 mm
2.7Ø length 187.5 mm
55-300.30
55-301.30

Shaver-System



Shaver-System

complete 240 V **54-301.01**
complete 115 V **54-301.02**

consisting of:
Control unit
Handpiece with 3m Cable
Footpedal
Transport Case



2. Technical Specifications

Control Unit

Width: 360 mm
Height: 90 mm
Depth: 268 mm
Weight: 6 kg
Power input: 230 V AC / 50 Hz
Capacity: 50 VA
Fuses: 2 x 3 A automatic
Protection Class: I
Type: B
Mode of Operation: Intermittent operation with short time loading of 3 minutes
Oscillating Cycle: 1,2 s
Water Protection: IP X0
EN-Class: 2a
Connections: Handpiece, Footswitch

Handpiece

Length: 165 mm
Weight: 475 g
Speed Range: 1000/2000/3000/4000/5000 rpm +10%
length of cable:

Footswitch

Width: 266 mm
Height: 20 mm
Depth: 209 mm
Weight: 1400 g
Mode of Operation: Clockwise, Counterclockwise, Oscillation, Speed Level Adjustment
Length of cable: 3 m

Power cord: 230 V, 10 A, 3-pole



Power Drill 54-301.05

- length: 165 mm
- weight: 840g
- speed: 100 / 250 / 400 / 550 / 700
- incl. Chuck key
- water resistant
- autoclavable
- length of cable: 3 m
- free of service



Saw 54-301.06

- length: 190 mm
- weight: 450g
- cutting speed: 18500 U/min
- water resistant
- autoclavable
- length of cable: 3 m
- free of service



Arthroscopy pump

Type:	54-300.01
Dimensions (W x D x H)	360 x 268 x 150 mm
Weight:	14 kg
Nominal input voltage:	230 VAC / 50 Hz
Primary fuses:	2 x 3 A
Power consumption:	90 VA
Pressure:	0 - 280 mmHg
Sppeed:	200 - 450 rpm
Flow rate:	0-1500 ml/min
Pressure control:	electronic
Class of protection:	I
Applicator:	type BF
Type of protection:	IP X0
EN category:	2a
Cleaning:	Surface cleaning with mild detergent

- Tube set for patient section

- Tube set for pump section

- Pressure sensor

- Power cable Type: 230 V, 10 A, three-pole

Tendon Forceps with ratchet



15,0 cm 54-321.15
19,0 cm 54-321.19
24,0 cm 54-321.24

Tendon Button

4 Loch / Holes
4 x 12 mm



55-007.04



Suture Disk, ø 14 mm
Reintitan
Pure titanium
55-007.30



55-007.40 Passierdraht ø 2,4 mm mit Öse und Spiralspitze Länge: 28 cm
Passing Pin ø 2.4 mm with Eye and Drill Tip Length: 28 cm



Suture Disk, ø 14 mm
mit Rotationssperre
Reintitan
with rotation fixation
Pure titanium
55-007.32

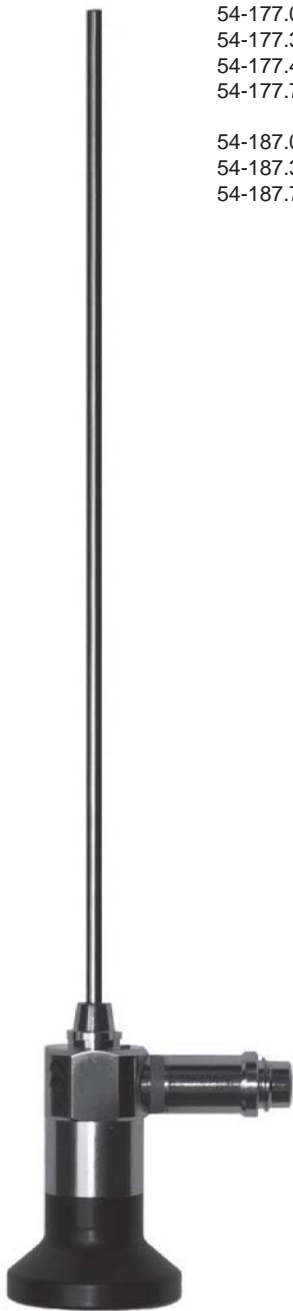

- | | |
|-----------|---|
| 54-177.00 | Endoscope 4,0 mm dia. 175 mm length 0° |
| 54-177.30 | Endoscope 4,0 mm dia. 175 mm length 30° |
| 54-177.45 | Endoscope 4,0 mm dia. 175 mm length 45° |
| 54-177.70 | Endoscope 4,0 mm dia. 175 mm length 70° |
| 54-187.00 | Endoscope 2,7 mm dia. 187 mm length 0° |
| 54-187.30 | Endoscope 2,7 mm dia. 187 mm length 30° |
| 54-187.70 | Endoscope 2,7 mm dia. 187 mm length 70° |



Full Radius Resector



Aggressive Full Radius

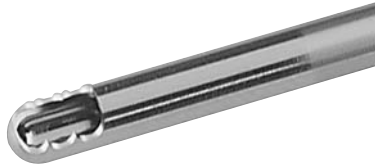

Meniscus Cutter



Trimmer

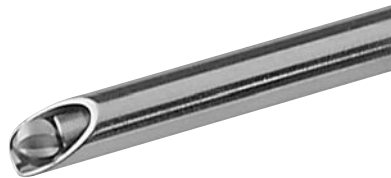

Round Burr



Single-use

- | | |
|-----------|---|
| 54-400.35 | Shaver-Blade ø 3,5 mm Full Resector, single use, each blade sterile packed, packing unit 5 pcs |
| 54-401.35 | Shaver-Blade ø 3,5 mm Aggressive Full Radius, single use, each blade sterile packed, packing unit 5 pcs |
| 54-402.35 | Shaver-Blade ø 3,5 mm Meniscus Cutter, single use, each blade sterile packed, packing unit 5 pcs |
| 54-403.35 | Shaver-Blade ø 3,5 mm Trimmer, single use, each blade sterile packed, packing unit 5 pcs |
| 54-404.42 | Shaver-Blade ø 4,2 mm Full Resector, single use, each blade sterile packed, packing unit 5 pcs |
| 54-405.42 | Shaver-Blade ø 4,2 mm Aggressive Full Radius, single use, each blade sterile packed, packing unit 5 pcs |
| 54-406.42 | Shaver-Blade ø 4,2 mm Meniscus Cutter, single use, each blade sterile packed, packing unit 5 pcs |
| 54-407.42 | Shaver-Blade ø 4,2 mm Trimmer, single use, each blade sterile packed, packing unit 5 pcs |

Multi-use

- | | |
|-----------|--|
| 54-420.35 | Shaver-Blade ø 3,5 mm Full Resector, multi use, stainless steel adapter |
| 54-421.35 | Shaver-Blade ø 3,5 mm Aggressive Full Radius, multi use, stainless steel adapter |
| 54-422.35 | Shaver-Blade ø 3,5 mm Meniscus Cutter, multi use, stainless steel adapter |
| 54-423.35 | Shaver-Blade ø 3,5 mm Trimmer, multi use, stainless steel adapter |
| 54-424.42 | Shaver-Blade ø 4,2 mm Full Resector, multi use, stainless steel adapter |
| 54-425.42 | Shaver-Blade ø 4,2 mm Aggressive Full Radius, multi use, stainless steel adapter |
| 54-426.42 | Shaver-Blade ø 4,2 mm Meniscus Cutter, multi use, stainless steel adapter |
| 54-427.42 | Shaver-Blade ø 4,2 mm Trimmer, multi use, stainless steel adapter |

Interferenzschrauben kannuliert Interference screws cannulated



- | | |
|-----------|--|
| 54-450.20 | Titanium Interference Screw, cannulated dia. 7 x 20 mm, flat head |
| 54-450.25 | Titanium Interference Screw, cannulated dia. 7 x 25 mm, flat head |
| 54-450.30 | Titanium Interference Screw, cannulated dia. 7 x 30 mm, flat head |
| 54-451.20 | Titanium Interference Screw, cannulated dia. 8 x 20 mm, flat head |
| 54-451.25 | Titanium Interference Screw, cannulated dia. 8 x 25 mm, flat head |
| 54-451.30 | Titanium Interference Screw, cannulated dia. 8 x 30 mm, flat head |
| 54-452.20 | Titanium Interference Screw, cannulated dia. 9 x 20 mm, flat head |
| 54-452.25 | Titanium Interference Screw, cannulated dia. 9 x 25 mm, flat head |
| 54-452.30 | Titanium Interference Screw, cannulated dia. 9 x 30 mm, flat head |
| 54-453.20 | Titanium Interference Screw, cannulated dia. 7 x 20 mm, round head |
| 54-453.25 | Titanium Interference Screw, cannulated dia. 7 x 25 mm, round head |
| 54-453.30 | Titanium Interference Screw, cannulated dia. 7 x 30 mm, round head |
| 54-454.20 | Titanium Interference Screw, cannulated dia. 8 x 20 mm, round head |
| 54-454.25 | Titanium Interference Screw, cannulated dia. 8 x 25 mm, round head |
| 54-454.30 | Titanium Interference Screw, cannulated dia. 8 x 30 mm, round head |
| 54-425.20 | Titanium Interference Screw, cannulated dia. 9 x 20 mm, round head |
| 54-455.25 | Titanium Interference Screw, cannulated dia. 9 x 25 mm, round head |
| 54-455.30 | Titanium Interference Screw, cannulated dia. 9 x 30 mm, round head |



54-530.01 Hightrans light cable Fiber 48 mm

Hightrans light cable, armoured but highly flexible strain relieved by kevlar and protected by sturdy silicone hose, autoclavable with warranty, bend protection in the inside, light source end temperature resistant up to 300°, integrated strain relief, no electrical interferences with endoscopy surgery units, (min. 5000 V overvoltage protection).

Incl. adapters for your endoscope and light source. Without specification, light cable will be completed with Storz adapter on the endoscope part 2 and also Storz adapter on the light source part 1. For any adapter combination advise when placing the order.

Length: 2,3 m
Fiber: ø 4,8 mm



54-550.01 Camera C1 Multi

- LED ON/OFF indicator
White balance and window button,
preset-function with three selectable
basic setups, all with OSD/LED indicator
contrast / brightness adjustment with OSD indicator
- System
TV-System PAL, NTSC, 1/2" CCD- Chip
470,000 pix. PAL 460/NTSC 470 lines
horizontal, digital 10-Bit technology
- Inputs/Outputs

Y/C	1 x Mini- DIN 4pol.
FBAS	1 x BNC
- Protection class
BF/CE-mark, approved according EN 60601-1
- Power
100 V/ 240 V, 50 / 60 Hz, 25 VA
potential equalization
- Dimensions and weight

Camera station (W/H/D):	360 x 85 x 320 mm
Camera Head (L/ø):	90 x 20 mm
Camera Head	
incl. adapter (L/ø):	140 x 32 mm
Camera cable.	3 mm
Weight:	app. 4 kg



54-550.03

3CCD-Camera C3 Multi

Surgeons have tested this camera for functionality and ergonomomy.

- Camera-Station / -head
 - LED ON/OFF indicator
 - White balance and window button,
 - preset-function with three selectable
 - basic setups, all with OSD/LED indicator
 - and modifiable by OSD-steering,
 - Brightness adjustment with OSD indicator
 - Control elements at camera head: White
 - balance, external functions

- System
 - TV-System PAL, NTSC, 3x1/3" CCD- Chip 750 lines
- Inputs/Outputs

RGB-Video	1 x Sub-D, 15 pol. HD
Y/C	2 x Mini-DIN 4 pol.
FBAS	1 x BMC

- Control

	1 socket for connector-ø 3.5 mm
--	---------------------------------

- Protection class
 - BF/CE-mark, approved according EN 60601-1

- Power
 - 100 V/ 240 V, 50 / 60 Hz, 25 VA
 - potential equalization

- Dimensions and weight

Camera station (W/H/D):	360 x 88 x 320 mm
Camera Head (W/H/L):	32 x 49 x 75 mm
Camera Head	
incl. adapter (W/H/L):	44 x 49 x 123 mm
Camera cable.	3 mm
Weight:	app. 4 kg

Delivery inclusive control unit, camera head, camera cable and plug



54-560.01

Halogen-Light Sources

Halogen-Power-Light Source

In specially designed PVC-housing with intergrated handle;
easy lamp exchange via removable top cover

Lamp power:	150 W
Maximal illumination:	9.2 Mio Lux
Color temperature:	3250° Kelvin
Average lamp life:	Step 4: 1500 hrs. Step 5: 200 hrs.
Dimensions (W/D/H)	168 x 268 x 120 mm
Intensity Control:	infinitely adjustable
Filter inserts:	lateral
Insulation (Protection class):	1
Approval:	CE

220 - 230 Volt AC, 50 - 60 Hz



54-570.00

Halogen-Light Sources

Halogen-Light Source

High-Power-Economy-Light Source, switchable, with integrated Spare Lamp
High intensity, incl. iris diaphragm, powerful fan, optical light concentrator for optimized use
of the existing light energy, Storz light guide adaption. According EN 60601-1

Lamp power:	1 x 250 W active position 1 x 250 W spare position
Color temperature:	3200° Kelvin
Light output:	12 Mio. Lux
Avery lamp life:	app. 50 hrs.
Power supply:	115 - 230 V AC switchable (50 - 60 Hz)
Dimensions (W/D/H):	367 x 250 x 132 mm
	115 - 230 Volt AC, 50 - 60 Hz



54-580.00

Xenon-Light Sources

Video Light Source with optimized 180 W Xenon lamp. Compact and powerful Xenon-Light Source for all applications and needs. A low noise and air turbulence reduced fan combines superb cooling of the unit without boaring noise during the operation. A manual crescent diaphragm changes the color intensity without changing the color temperature. Built for TV applications and all endoscope dimensions.

Color temp:	6000° Kelvin
Nominal power:	180 Watt
Avery Lamp life:	app. 500 hrs.
Light output:	25 Mio Lux
Dimensions (W/D/H):	360 x 320 x 128 mm
Weight	app. 6 kg
Controls:	ON/OFF with LED indicator
Remaining lamp life:	indicator
Connector for light cable adaptors:	System Storz
Turning knob:	adjustment diaphragme

100 Volt / 240 Volt AC, 50 / 60 Hz 25 VA



54-610.19 LCD Screen 19"
54-620.00 OP Trolley

ORIHOMEDICAL

G m b H · I M P L A N T S

Hauptstrasse 5 · D-78589 Dürbheim
Tel.: 0 74 24 / 94 03-40 · Fax: 0 74 24 / 94 03-43
www.orthomedical.de · email: mail@orthomedical.de
